

INSTRUCTION MANUAL



# Cordless Jig Saw

DJV140

DJV180

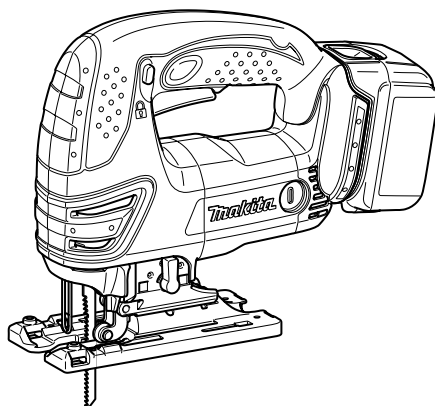

007481

**IMPORTANT:** Read Before Using.

## ENGLISH (Original instructions)

# SPECIFICATIONS

Model	DJV140	DJV180
Length of stroke	26 mm	26 mm
Max. cutting capacities	Wood	135 mm
	Mild steel	10 mm
	Aluminum	20 mm
Strokes per minute (min <sup>-1</sup> )	0 - 2,600	0 - 2,600
Overall length	255 mm	257 mm
Net weight	2.8 kg	2.9 kg
Rated voltage	D.C. 14.4 V	D.C. 18 V

- Due to our continuing program of research and development, the specifications herein are subject to change without notice.
- Specifications and battery cartridge may differ from country to country.
- Weight, with battery cartridge, according to EPTA-Procedure 01/2003

END004-6

## Symbols

The following show the symbols used for the equipment. Be sure that you understand their meaning before use.



- Read instruction manual.



Cd  
Ni-MH  
Li-ion

- Only for EU countries

Do not dispose of electric equipment or battery pack together with household waste material!

In observance of the European Directives, on Waste Electric and Electronic Equipment and Batteries and Accumulators and Waste Batteries and Accumulators and their implementation in accordance with national laws, electric equipment and batteries and battery pack(s) that have reached the end of their life must be collected separately and returned to an environmentally compatible recycling facility.

ENE019-1

## Intended use

The tool is intended for the sawing of wood, plastic and metal materials. As a result of the extensive accessory and saw blade program, the tool can be used for many purposes and is very well suited for curved or circular cuts.

ENG905-1

## Noise

The typical A-weighted noise level determined according to EN60745:

### Model DJV140

Sound pressure level ( $L_{pA}$ ) : 83 dB (A)  
Sound power level ( $L_{WA}$ ) : 94 dB (A)  
Uncertainty (K) : 3 dB (A)

### Model DJV180

Sound pressure level ( $L_{pA}$ ) : 84 dB (A)  
Sound power level ( $L_{WA}$ ) : 95 dB (A)  
Uncertainty (K) : 3 dB (A)

## Wear ear protection

ENG900-1

## Vibration

The vibration total value (tri-axial vector sum) determined according to EN60745:

Work mode : cutting boards  
Vibration emission ( $a_{h,B}$ ) : 7.0 m/s<sup>2</sup>  
Uncertainty (K) : 1.5 m/s<sup>2</sup>

Work mode : cutting sheet metal  
Vibration emission ( $a_{h,M}$ ) : 3.5 m/s<sup>2</sup>  
Uncertainty (K) : 1.5 m/s<sup>2</sup>

ENG901-1

- The declared vibration emission value has been measured in accordance with the standard test method and may be used for comparing one tool with another.
- The declared vibration emission value may also be used in a preliminary assessment of exposure.

## ⚠ WARNING:

- The vibration emission during actual use of the power tool can differ from the declared emission value depending on the ways in which the tool is used.
- Be sure to identify safety measures to protect the operator that are based on an estimation of exposure in the actual conditions of use (taking account of all parts of the operating cycle such as the times when the tool is switched off and when it is running idle in addition to the trigger time).

**For European countries only****EC Declaration of Conformity**

**Makita declares that the following Machine(s):**

Designation of Machine:

Cordless Jig Saw

Model No./ Type: DJV140, DJV180

**Conforms to the following European Directives:**

2006/42/EC

They are manufactured in accordance with the following standard or standardized documents:

EN60745

The Technical file in accordance with 2006/42/EC is available from:

Makita, Jan-Baptist Vinkstraat 2, 3070, Belgium

31.12.2013



000331

Yasushi Fukaya

Director

Makita, Jan-Baptist Vinkstraat 2, 3070, Belgium

GEA006-2

## General Power Tool Safety Warnings

**⚠ WARNING** Read all safety warnings and all instructions. Failure to follow the warnings and instructions may result in electric shock, fire and/or serious injury.

### Save all warnings and instructions for future reference.

The term "power tool" in the warnings refers to your mains-operated (corded) power tool or battery-operated (cordless) power tool.

#### Work area safety

1. **Keep work area clean and well lit.** Cluttered or dark areas invite accidents.
2. **Do not operate power tools in explosive atmospheres, such as in the presence of flammable liquids, gases or dust.** Power tools create sparks which may ignite the dust or fumes.
3. **Keep children and bystanders away while operating a power tool.** Distractions can cause you to lose control.

#### Electrical safety

4. **Power tool plugs must match the outlet. Never modify the plug in any way. Do not use any adapter plugs with earthed (grounded) power tools.** Unmodified plugs and matching outlets will reduce risk of electric shock.

5. **Avoid body contact with earthed or grounded surfaces such as pipes, radiators, ranges and refrigerators.** There is an increased risk of electric shock if your body is earthed or grounded.
6. **Do not expose power tools to rain or wet conditions.** Water entering a power tool will increase the risk of electric shock.
7. **Do not abuse the cord. Never use the cord for carrying, pulling or unplugging the power tool. Keep cord away from heat, oil, sharp edges or moving parts.** Damaged or entangled cords increase the risk of electric shock.
8. **When operating a power tool outdoors, use an extension cord suitable for outdoor use.** Use of a cord suitable for outdoor use reduces the risk of electric shock.
9. **If operating a power tool in a damp location is unavoidable, use a ground fault circuit interrupter (GFCI) protected supply.** Use of an GFCI reduces the risk of electric shock.

#### Personal safety

10. **Stay alert, watch what you are doing and use common sense when operating a power tool. Do not use a power tool while you are tired or under the influence of drugs, alcohol or medication.** A moment of inattention while operating power tools may result in serious personal injury.
11. **Use personal protective equipment. Always wear eye protection.** Protective equipment such as dust mask, non-skid safety shoes, hard hat, or hearing protection used for appropriate conditions will reduce personal injuries.
12. **Prevent unintentional starting. Ensure the switch is in the off-position before connecting to power source and/or battery pack, picking up or carrying the tool.** Carrying power tools with your finger on the switch or energising power tools that have the switch on invites accidents.
13. **Remove any adjusting key or wrench before turning the power tool on.** A wrench or a key left attached to a rotating part of the power tool may result in personal injury.
14. **Do not overreach. Keep proper footing and balance at all times.** This enables better control of the power tool in unexpected situations.
15. **Dress properly. Do not wear loose clothing or jewellery. Keep your hair, clothing, and gloves away from moving parts.** Loose clothes, jewellery or long hair can be caught in moving parts.
16. **If devices are provided for the connection of dust extraction and collection facilities, ensure these are connected and properly used.** Use of dust collection can reduce dust-related hazards.

### Power tool use and care

17. **Do not force the power tool. Use the correct power tool for your application.** The correct power tool will do the job better and safer at the rate for which it was designed.
18. **Do not use the power tool if the switch does not turn it on and off.** Any power tool that cannot be controlled with the switch is dangerous and must be repaired.
19. **Disconnect the plug from the power source and/or the battery pack from the power tool before making any adjustments, changing accessories, or storing power tools.** Such preventive safety measures reduce the risk of starting the power tool accidentally.
20. **Store idle power tools out of the reach of children and do not allow persons unfamiliar with the power tool or these instructions to operate the power tool.** Power tools are dangerous in the hands of untrained users.
21. **Maintain power tools. Check for misalignment or binding of moving parts, breakage of parts and any other condition that may affect the power tool's operation. If damaged, have the power tool repaired before use.** Many accidents are caused by poorly maintained power tools.
22. **Keep cutting tools sharp and clean.** Properly maintained cutting tools with sharp cutting edges are less likely to bind and are easier to control.
23. **Use the power tool, accessories and tool bits etc. in accordance with these instructions, taking into account the working conditions and the work to be performed.** Use of the power tool for operations different from those intended could result in a hazardous situation.

### Battery tool use and care

24. **Recharge only with the charger specified by the manufacturer.** A charger that is suitable for one type of battery pack may create a risk of fire when used with another battery pack.
25. **Use power tools only with specifically designated battery packs.** Use of any other battery packs may create a risk of injury and fire.
26. **When battery pack is not in use, keep it away from other metal objects, like paper clips, coins, keys, nails, screws or other small metal objects, that can make a connection from one terminal to another.** Shorting the battery terminals together may cause burns or a fire.
27. **Under abusive conditions, liquid may be ejected from the battery; avoid contact. If contact accidentally occurs, flush with water. If liquid contacts eyes, additionally seek medical help.** Liquid ejected from the battery may cause irritation or burns.

### Service

28. **Have your power tool serviced by a qualified repair person using only identical replacement parts.** This will ensure that the safety of the power tool is maintained.
29. **Follow instruction for lubricating and changing accessories.**
30. **Keep handles dry, clean and free from oil and grease.**

GEB045-2

## CORDLESS JIG SAW SAFETY WARNINGS

1. **Hold power tool by insulated gripping surfaces, when performing an operation where the cutting accessory may contact hidden wiring.** Cutting accessory contacting a "live" wire may make exposed metal parts of the power tool "live" and could give the operator an electric shock.
2. **Use clamps or another practical way to secure and support the workpiece to a stable platform.** Holding the work by hand or against your body leaves it unstable and may lead to loss of control.
3. **Always use safety glasses or goggles. Ordinary eye or sun glasses are NOT safety glasses.**
4. **Avoid cutting nails. Inspect workpiece for any nails and remove them before operation.**
5. **Do not cut oversize workpiece.**
6. **Check for the proper clearance beyond the workpiece before cutting so that the blade will not strike the floor, workbench, etc.**
7. **Hold the tool firmly.**
8. **Make sure the blade is not contacting the workpiece before the switch is turned on.**
9. **Keep hands away from moving parts.**
10. **Do not leave the tool running. Operate the tool only when hand-held.**
11. **Always switch off and wait for the blade to come to a complete stop before removing the blade from the workpiece.**
12. **Do not touch the blade or the workpiece immediately after operation; they may be extremely hot and could burn your skin.**
13. **Do not operate the tool at no-load unnecessarily.**
14. **Some material contains chemicals which may be toxic. Take caution to prevent dust inhalation and skin contact. Follow material supplier safety data.**
15. **Always use the correct dust mask/respirator for the material and application you are working with.**

## SAVE THESE INSTRUCTIONS.

**⚠WARNING:**

DO NOT let comfort or familiarity with product (gained from repeated use) replace strict adherence to safety rules for the subject product. MISUSE or failure to follow the safety rules stated in this instruction manual may cause serious personal injury.

ENC007-8

## **IMPORTANT SAFETY INSTRUCTIONS**

### **FOR BATTERY CARTRIDGE**

1. Before using battery cartridge, read all instructions and cautionary markings on (1) battery charger, (2) battery, and (3) product using battery.
2. Do not disassemble battery cartridge.
3. If operating time has become excessively shorter, stop operating immediately. It may result in a risk of overheating, possible burns and even an explosion.
4. If electrolyte gets into your eyes, rinse them out with clear water and seek medical attention right away. It may result in loss of your eyesight.
5. Do not short the battery cartridge:
  - (1) Do not touch the terminals with any conductive material.
  - (2) Avoid storing battery cartridge in a container with other metal objects such as nails, coins, etc.
  - (3) Do not expose battery cartridge to water or rain.

A battery short can cause a large current flow, overheating, possible burns and even a breakdown.
6. Do not store the tool and battery cartridge in locations where the temperature may reach or exceed 50 ° C (122 ° F).
7. Do not incinerate the battery cartridge even if it is severely damaged or is completely worn out. The battery cartridge can explode in a fire.
8. Be careful not to drop or strike battery.
9. Do not use a damaged battery.
10. Follow your local regulations relating to disposal of battery.

## **SAVE THESE INSTRUCTIONS.**

### **Tips for maintaining maximum battery life**

1. Charge the battery cartridge before completely discharged. Always stop tool operation and charge the battery cartridge when you notice less tool power.
2. Never recharge a fully charged battery cartridge. Overcharging shortens the battery service life.
3. Charge the battery cartridge with room temperature at 10 ° C - 40 ° C (50 ° F - 104 ° F). Let a hot battery cartridge cool down before charging it.
4. Charge the battery cartridge once in every six months if you do not use it for a long period of time.

## FUNCTIONAL DESCRIPTION

### ⚠CAUTION:

- Always be sure that the tool is switched off and the battery cartridge is removed before adjusting or checking function on the tool.

### Installing or removing battery cartridge

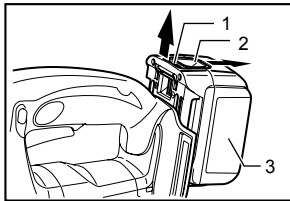

007482

1. Red indicator
2. Button
3. Battery cartridge

### ⚠CAUTION:

- Always switch off the tool before installing or removing of the battery cartridge.
- **Hold the tool and the battery cartridge firmly when installing or removing battery cartridge.** Failure to hold the tool and the battery cartridge firmly may cause them to slip off your hands and result in damage to the tool and battery cartridge and a personal injury.

To remove the battery cartridge, slide it from the tool while sliding the button on the front of the cartridge.

To install the battery cartridge, align the tongue on the battery cartridge with the groove in the housing and slip it into place. Insert it all the way until it locks in place with a little click. If you can see the red indicator on the upper side of the button, it is not locked completely.

### ⚠CAUTION:

- Always install the battery cartridge fully until the red indicator cannot be seen. If not, it may accidentally fall out of the tool, causing injury to you or someone around you.
- Do not install the battery cartridge forcibly. If the cartridge does not slide in easily, it is not being inserted correctly.

## Battery protection system (Lithium-ion battery with star marking)

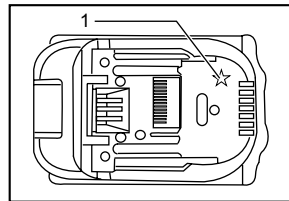

1. Star marking

012128

Lithium-ion batteries with a star marking are equipped with a protection system. This system automatically cuts off power to the tool to extend battery life.

The tool will automatically stop during operation if the tool and/or battery are placed under one of the following conditions:

- **Overloaded:**

The tool is operated in a manner that causes it to draw an abnormally high current. In this situation, release the switch trigger on the tool and stop the application that caused the tool to become overloaded. Then pull the switch trigger again to restart. If the tool does not start, the battery is overheated. In this situation, let the battery cool before pulling the switch trigger again.
- **Low battery voltage:**

The remaining battery capacity is too low and the tool will not operate. In this situation, remove and recharge the battery.

## Selecting the cutting action

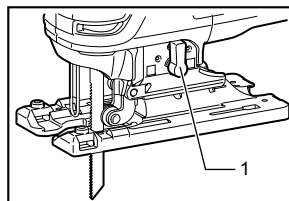

1. Cutting action changing lever

007483

This tool can be operated with an orbital or a straight line (up and down) cutting action. The orbital cutting action thrusts the blade forward on the cutting stroke and greatly increases cutting speed.

To change the cutting action, just turn the cutting action changing lever to the desired cutting action position. Refer to the table to select the appropriate cutting action.

Position	Cutting action	Applications
0	Straight line cutting action	For cutting mild steel, stainless steel and plastics. For clean cuts in wood and plywood.
I	Small orbit cutting action	For cutting mild steel, aluminum and hard wood.
II	Medium orbit cutting action	For cutting wood and plywood. For fast cutting in aluminum and mild steel.
III	Large orbit cutting action	For fast cutting in wood and plywood.

006376

### Switch action

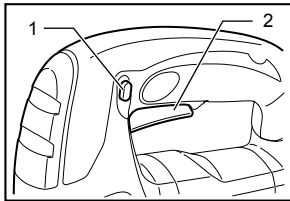

1. Lock-off button
2. Switch trigger

007484

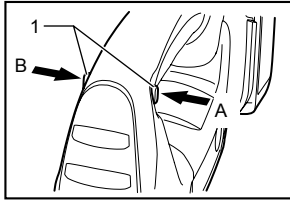

1. Lock-off button

007485

### ⚠CAUTION:

- Before inserting the battery cartridge into the tool, always check to see that the switch trigger actuates properly and returns to the "OFF" position when released.
- When not operating the tool, depress the lock-off button from A side to lock the switch trigger in the OFF position.

To prevent the switch trigger from accidentally pulled, the lock-off button is provided.

To start the tool, depress the lock-off button from B side and pull the switch trigger.

Tool speed is increased by increasing pressure on the switch trigger. Release the switch trigger to stop. After use, always press in the lock-off button from A side.

### Lighting up the lamps

#### ⚠CAUTION:

- Do not look in the light or see the source of light directly.

To turn on the lamp, pull the trigger. Release the trigger to turn it off.

#### NOTE:

- Use a dry cloth to wipe the dirt off the lens of lamp. Be careful not to scratch the lens of lamp, or it may lower the illumination.

### ASSEMBLY

#### ⚠CAUTION:

- Always be sure that the tool is switched off and the battery cartridge is removed before carrying out any work on the tool.

### Installing or removing saw blade

#### ⚠CAUTION:

- Always clean out all chips or foreign matter adhering to the blade and/or blade holder. Failure to do so may cause insufficient tightening of the blade, resulting in a serious personal injury.
- Do not touch the blade or the workpiece immediately after operation; they may be extremely hot and could burn your skin.
- Tighten the saw blade securely. Failure to do so may cause a serious injury.
- When you remove the saw blade, be careful not to hurt your fingers with the top of the blade or the tips of workpiece.

To install the blade, open the tool opener to the position shown in the figure.

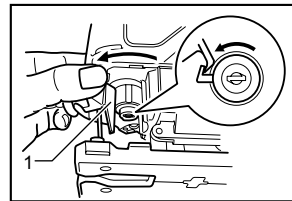

1. Tool opener

001909

Keeping that situation, insert the saw blade into the blade clamp as far as the two protrusions of the blade can not be seen.

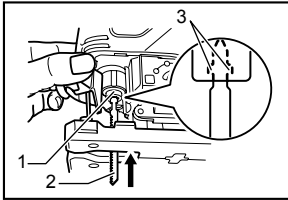

1. Blade clamp
2. Jig saw blade
3. Protrusions

001910

Return the tool opener to its original position. After installing, always make sure that the blade is securely held in place by trying to pull it out.

**⚠CAUTION:**

- Do not open the tool opener excessively, or it may cause tool damage.

To remove the blade, open the tool opener to the position shown in the figure. Pull the saw blade out toward the base.

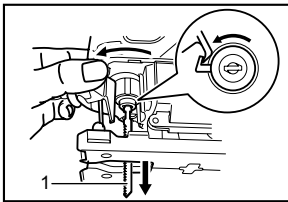

1. Jig saw blade

001911

**NOTE:**

- Occasionally lubricate the roller.

**Hex wrench storage**

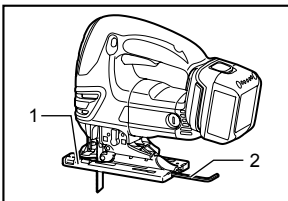

1. Base
2. Hex wrench

007486

When not in use, store the hex wrench as shown in the figure to keep it from being lost.

**Cover plate**

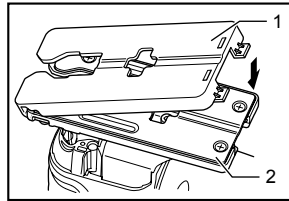

1. Cover plate
2. Base

007503

Use the cover plate when cutting decorative veneers, plastics, etc. It protects sensitive or delicate surfaces from damage. Fit it on the back of the tool base.

**Anti-splintering device**

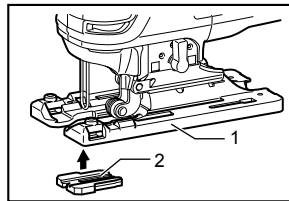

1. Base
2. Anti-splintering device

007504

For splinter-free cuts, the anti-splintering device can be used. To install the anti-splintering device, move the tool base all the way forward and fit it on the back of tool base. When you use the cover plate, install the anti-splintering device onto the cover plate.

**⚠CAUTION:**

- The anti-splintering device cannot be used when making bevel cuts.

**Dust extraction**

The dust nozzle (optional accessory) is recommended to perform clean cutting operations.

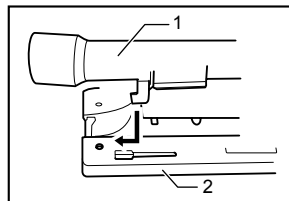

1. Dust nozzle
2. Base

001921

To attach the dust nozzle on the tool, insert the hook of dust nozzle into the hole in the base.

The dust nozzle can be installed on either left or right side of the base.



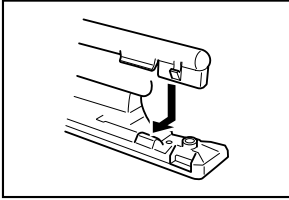

001922

Then connect a Makita vacuum cleaner to the dust nozzle.

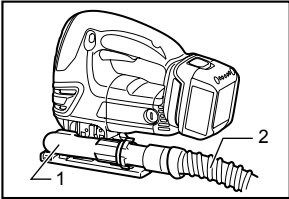

007495

1. Dust nozzle
2. Hose for vacuum cleaner

## OPERATION

### ⚠CAUTION:

- Always hold the base flush with the workpiece. Failure to do so may cause blade breakage, resulting in a serious injury.

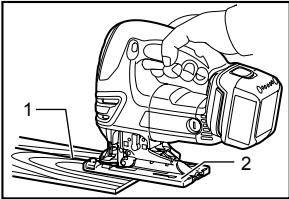

007487

Turn the tool on without the blade making any contact and wait until the blade attains full speed. Then rest the base flat on the workpiece and gently move the tool forward along the previously marked cutting line.

1. Cutting line
2. Base

### NOTE:

- If the tool is operated continuously until the battery cartridge has discharged, allow the tool to rest for 15 minutes before proceeding with a fresh battery. When cutting curves, advance the tool very slowly.

## Bevel cutting

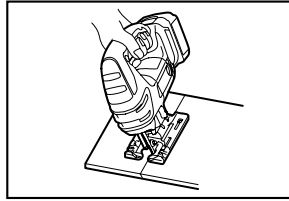

007488

### ⚠CAUTION:

- Always be sure that the tool is switched off and the battery cartridge is removed before tilting the base. With the base tilted, you can make bevel cuts at any angle between 0° and 45° (left or right). Loosen the bolt on the back of the base with the hex wrench. Move the base so that the bolt is positioned in the center of the bevel slot in the base.

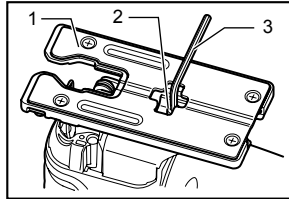

007489

Tilt the base until the desired bevel angle is obtained. The V-notch of the gear housing indicates the bevel angle by graduations. Then tighten the bolt firmly to secure the base.

1. Base
2. Bolt
3. Hex wrench

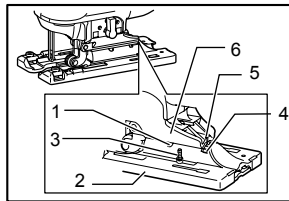

007490

1. Bevel slot
2. Base
3. Bolt
4. Graduations
5. V-notch
6. Gear housing

## Front flush cuts

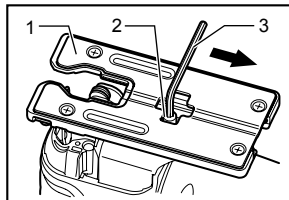

007491

1. Base
2. Bolt
3. Hex wrench

Loosen the bolt on the back of the base with the hex wrench and slide the base all the way back. Then tighten the bolt to secure the base.

### Cutouts

Cutouts can be made with either of two methods A or B.

#### A) Boring a starting hole:

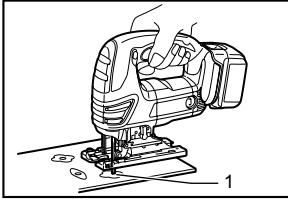

1. Starting hole

007492

- For internal cutouts without a lead-in cut from an edge, pre-drill a starting hole 12 mm or more in diameter. Insert the blade into this hole to start your cut.

#### B) Plunge cutting:

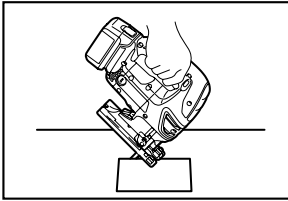

007493

- You need not bore a starting hole or make a lead-in cut if you carefully do as follows.
- Tilt the tool up on the front edge of the base with the blade point positioned just above the workpiece surface.
  - Apply pressure to the tool so that the front edge of the base will not move when you switch on the tool and gently lower the back end of the tool slowly.
  - As the blade pierces the workpiece, slowly lower the base of the tool down onto the workpiece surface.
  - Complete the cut in the normal manner.

### Finishing edges

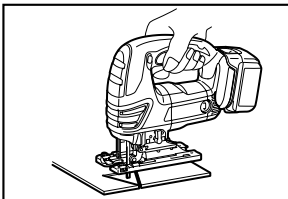

007494

To trim edges or make dimensional adjustments, run the blade lightly along the cut edges.

### Metal cutting

Always use a suitable coolant (cutting oil) when cutting metal. Failure to do so will cause significant blade wear. The underside of the workpiece can be greased instead of using a coolant.

### Rip fence set (optional accessory)

#### ⚠CAUTION:

- Always be sure that the tool is switched off and the battery cartridge is removed before installing or removing accessories.

#### 1. Straight cuts

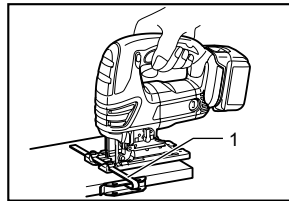

1. Rip fence

007496

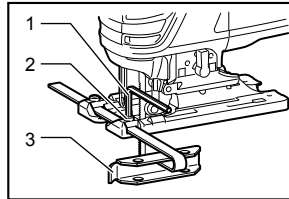

1. Hex wrench  
2. Bolt  
3. Fence guide

007497

When repeatedly cutting widths of 160 mm or less, use of the rip fence will assure fast, clean, straight cuts. To install, insert the rip fence into the rectangular hole on the side of the tool base with the fence guide facing down. Slide the rip fence to the desired cutting width position, then tighten the bolt to secure it.

#### 2. Circular cuts

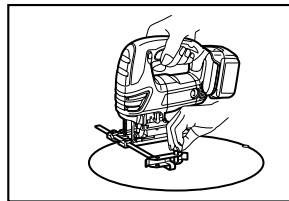

007498

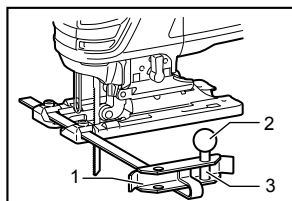

1. Fence guide
2. Threaded knob
3. Circular guide pin

007499

When cutting circles or arcs of 170 mm or less in radius, install the rip fence as follows.

- Insert the rip fence into the rectangular hole on the side of the base with the fence guide facing up. Insert the circular guide pin through either of the two holes on the fence guide. Screw the threaded knob onto the pin to secure the pin.
- Now slide the rip fence to the desired cutting radius, and tighten the bolt to secure it in place. Then move the base all the way forward.

**NOTE:**

- Always use blades No. B-17, B-18, B-26 or B-27 when cutting circles or arcs.

**Guide rail adapter set (accessory)**

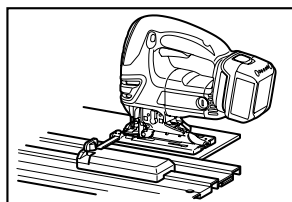

007500

When cutting parallel and uniform width or cutting straight, the use of the guide rail and the guide rail adapter will assure the production of fast and clean cuts.

To install the guide rail adapter, insert the rule bar into the square hole of the base as far as it goes. Secure the bolt with the hex wrench securely.

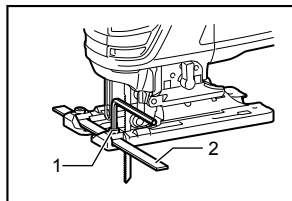

1. Bolt
2. Rule bar

007501

Install the guide rail adapter on the rail of the guide rail. Insert the rule bar into the square hole of the guide rail adapter. Put the base to the side of the guide rail, and secure the bolt securely.

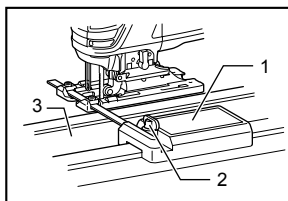

1. Guide rail adapter
2. Screw
3. Guide rail

007502

**CAUTION:**

- Always use blades No. B-8, B-13, B-16, B-17 or 58 when using the guide rail and the guide rail adapter.

**MAINTENANCE**

**CAUTION:**

- Always be sure that the tool is switched off and the battery cartridge is removed before attempting to perform inspection or maintenance.
- Never use gasoline, benzine, thinner, alcohol or the like. Discoloration, deformation or cracks may result.

**Replacing carbon brushes**

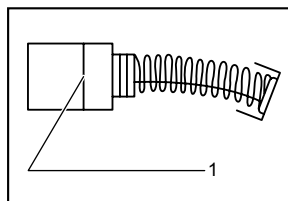

1. Limit mark

007145

Remove and check the carbon brushes regularly. Replace when they wear down to the limit mark. Keep the carbon brushes clean and free to slip in the holders. Both carbon brushes should be replaced at the same time. Use only identical carbon brushes.

Use a screwdriver to remove the brush holder caps. Take out the worn carbon brushes, insert the new ones and secure the brush holder caps.

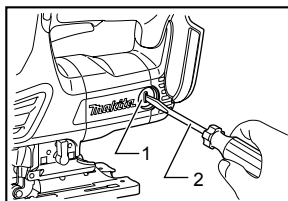

1. Brush holder cap
2. Screwdriver

007505

To maintain product SAFETY and RELIABILITY, repairs, any other maintenance or adjustment should be

---

performed by Makita Authorized Service Centers, always using Makita replacement parts.

## OPTIONAL ACCESSORIES

### CAUTION:

- These accessories or attachments are recommended for use with your Makita tool specified in this manual. The use of any other accessories or attachments might present a risk of injury to persons. Only use accessory or attachment for its stated purpose.

If you need any assistance for more details regarding these accessories, ask your local Makita Service Center.

- Jig saw blades
- Hex wrench 4
- Rip fence (guide rule) set
- Guide rail adapter set
- Guide rail set
- Anti-splintering device
- Cover plate
- Dust nozzle
- Makita genuine battery and charger

### NOTE:

- Some items in the list may be included in the tool package as standard accessories. They may differ from country to country.







**Makita** Jan-Baptist Vinkstraat 2, 3070, Belgium  
**Makita Corporation** Anjo, Aichi, Japan